Data Sheet for 5mm Super Bright Red LED

5A3 Series

Angle: 15°

Class: Q

Part No: WW05A3SRQ4-N

Data Sheet For 5mm Super Bright Red LED – 5A3 Series Angle 15° Class: Q

Features

- Standard T-1 Diameter Type Package.
- General Purpose Leads
- Reliable and Rugged

Absolute Maximum Ratings at Ta=25°C

Parameter	MAX.	Unit
Power Dissipation	50	mW
Peak Forward Current ($\leq 1/10$ Duty Cycle, 0.1ms Pulse Wide)	100	mA
Continuous Forward Current	20	mA
Derating Linear From 50°C	0.4	mA/°C
Reverse Voltage	5	V
Operating Temperature Range	-40°C to +80°C	
Storage Temperature Range	-40°C to +80°C	
Lead Soldering Temperature [4mm(.157") From Body]	260°C for 3 Seconds	

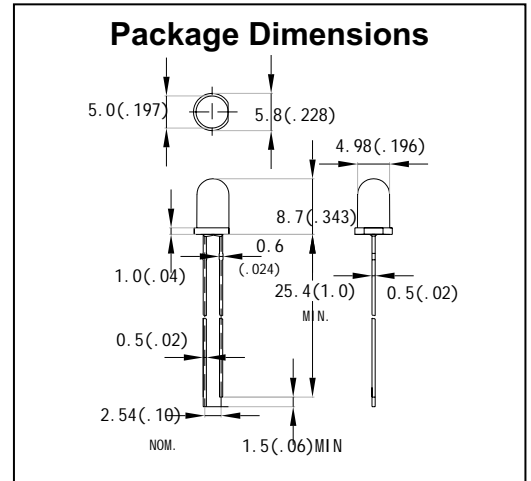

Electrical Optical Characteristics at Ta=25°C

Part Number	Lens color	Source Color	Dominant Wavelength λ_d / nm $I_F = 20\text{mA}$ (Note 8)			Luminous Intensity I_v / mcd $I_F = 20\text{mA}$ (Note 5)			Forward Voltage / V $I_F = 20\text{mA}$			Viewing Angle / Deg (Note 6)
			Min.	Typ.	Max.	Min.	Typ.	Max.	Min.	Typ.	Max.	
WW05A3SRQ4-N	Water Clear	Red	620	---	630	8200	10600	13800	---	2.0	2.4	15°
Reverse Voltage = 5V						Reverse Current = 50 μ A						

Notes:

1. All dimensions are in millimeter.
2. Tolerance of measurement is $\pm 0.25\text{mm}$ (.01") unless others otherwise noted.
3. Protruded resin under flanges is 1.0mm(.04") max.
4. Lead spacing is measured where the leads emerge from the package.
5. Luminous intensity is measured with a light sensor and filter combination that approximates the CIE eye-response curve. Tolerance of measurement of luminous intensity is $\pm 5\%$
6. $\theta_{1/2}$ is the off-axis angle at which the luminous intensity is half the axial luminous intensity. It use many parameters that correspond to the CIE 1931 2° Tolerance of measurement of angle is ± 5 degree
7. Caution in ESD: Static Electricity and surge damages the LED. It is recommended to use a wrist band or anti-electrostatic glove when handling the LED. All devices, equipment and machinery must be properly grounded.
8. The dominant wavelength λ_d is derived from the CIE chromaticity diagram and represents the single wavelength which defines the color of the device.
9. Specifications are subject to change without notice.

Super Bright Red LED "Q" Class Series Light Intensity (Iv) vs Time(T)

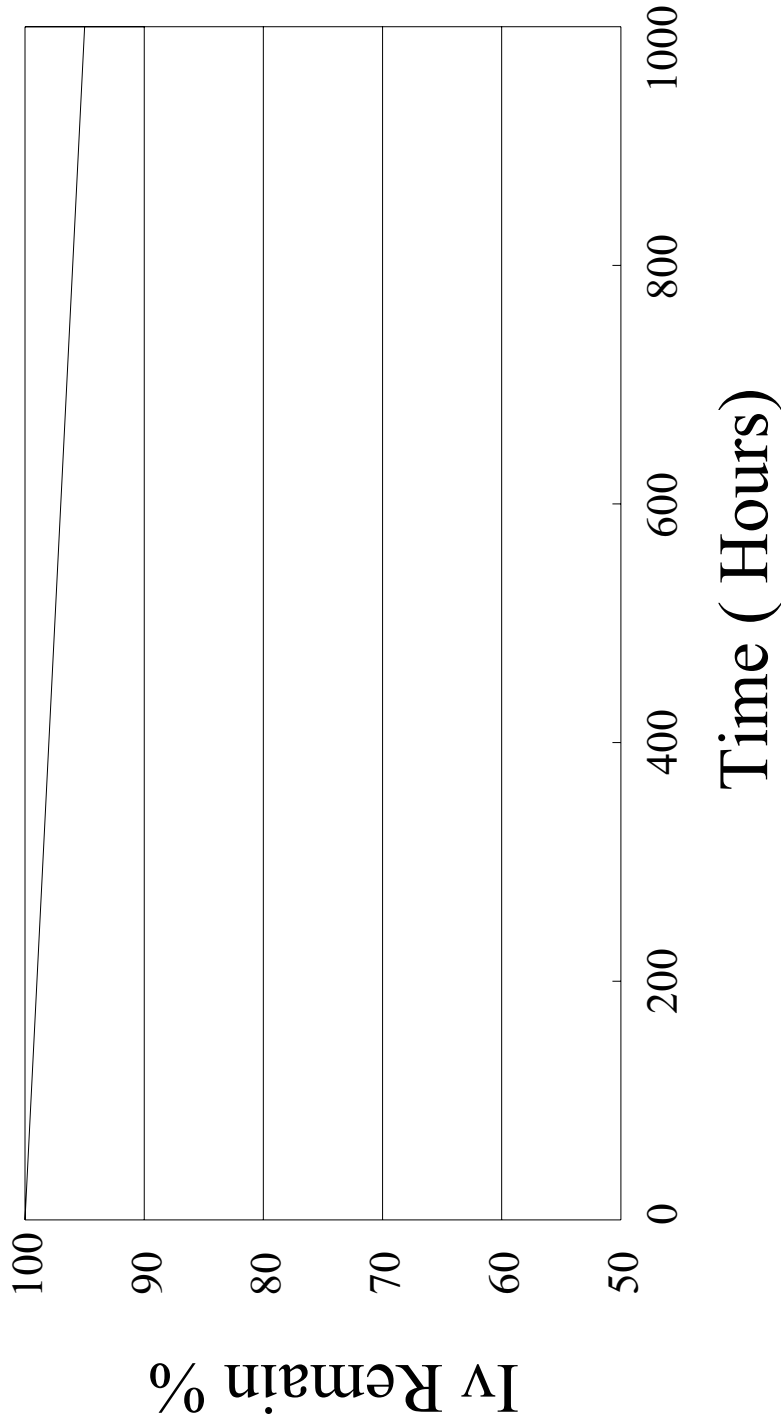

Operating Current : 20mA
Tj : 25° C

Typical Characteristic for Super Bright Red LED

Forward Current vs. Chromaticity Coordinate (λD)

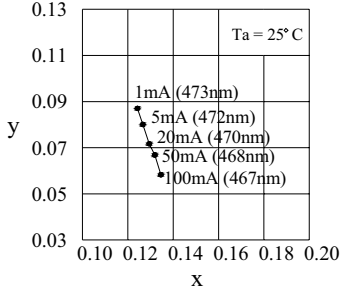

Forward Current vs. Dominant Wavelength

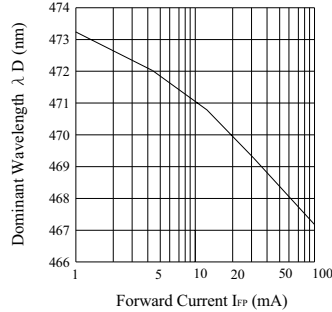

Spectrum

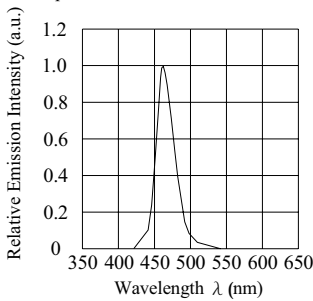

Ambient Temperature vs. Dominant Wavelength

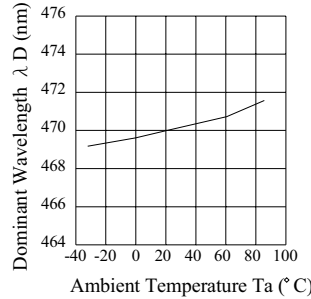

Directivity (Angle : 15°)

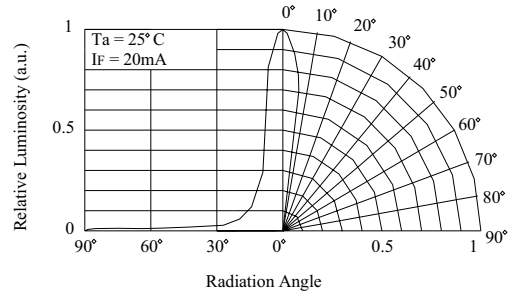

Forward Voltage vs. Forward Current

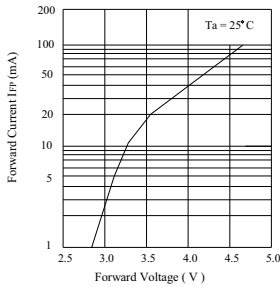

Ambient Temperature vs. Forward Voltage

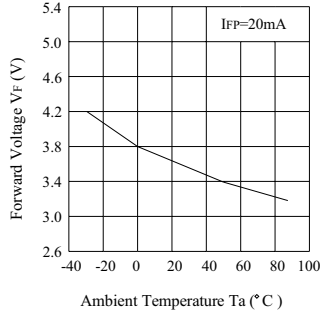

Ambient Temperature vs. Relative Luminosity

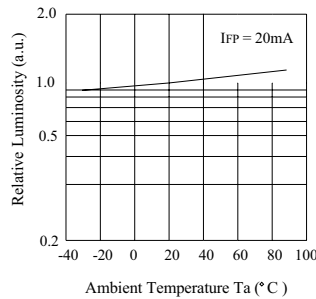

Duty Ratio vs. Allowable Forward Current

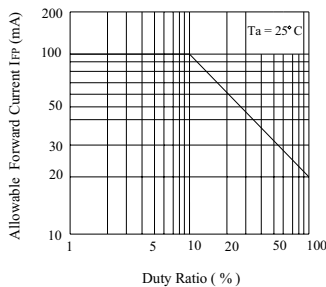

Forward Current vs. Relative Luminosity

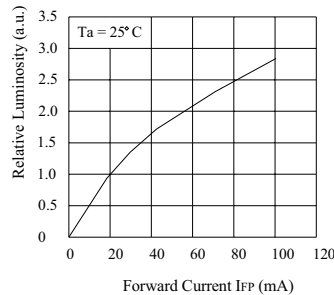

Ambient Temperature vs. Allowable Forward Current

